

1 2 3 4 5 6 7 8

D

D

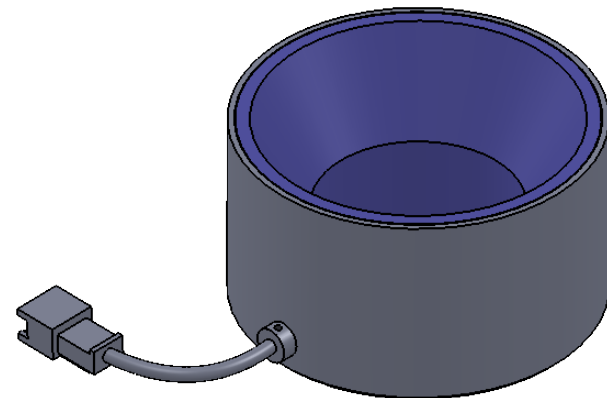
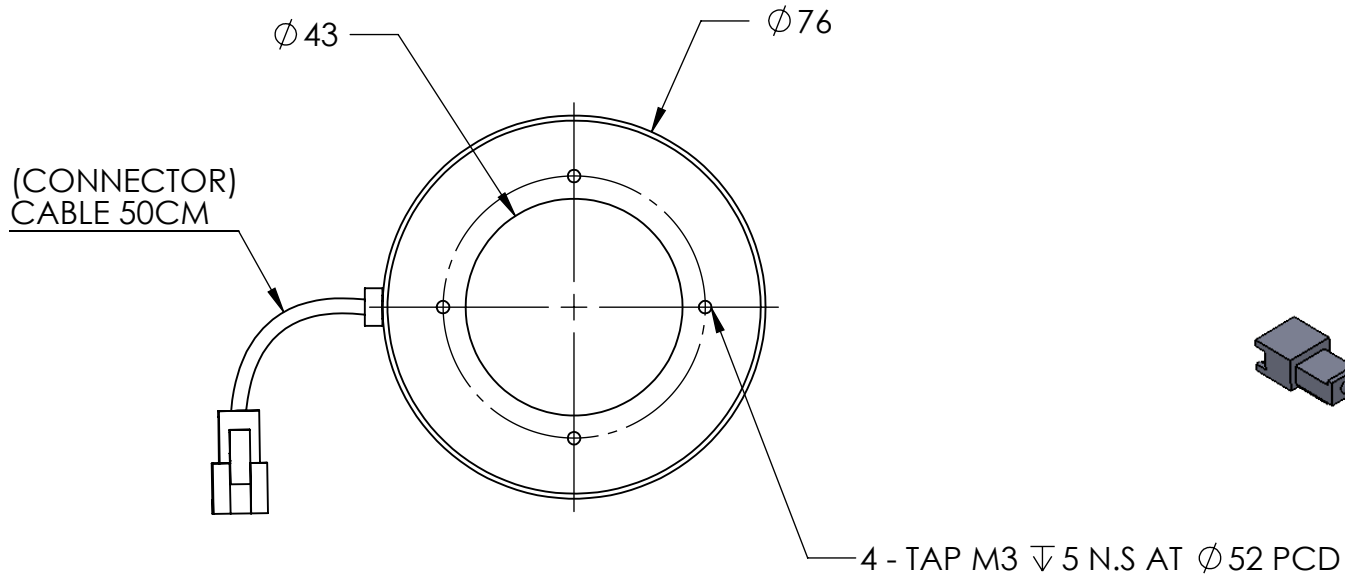

C

C

B

B

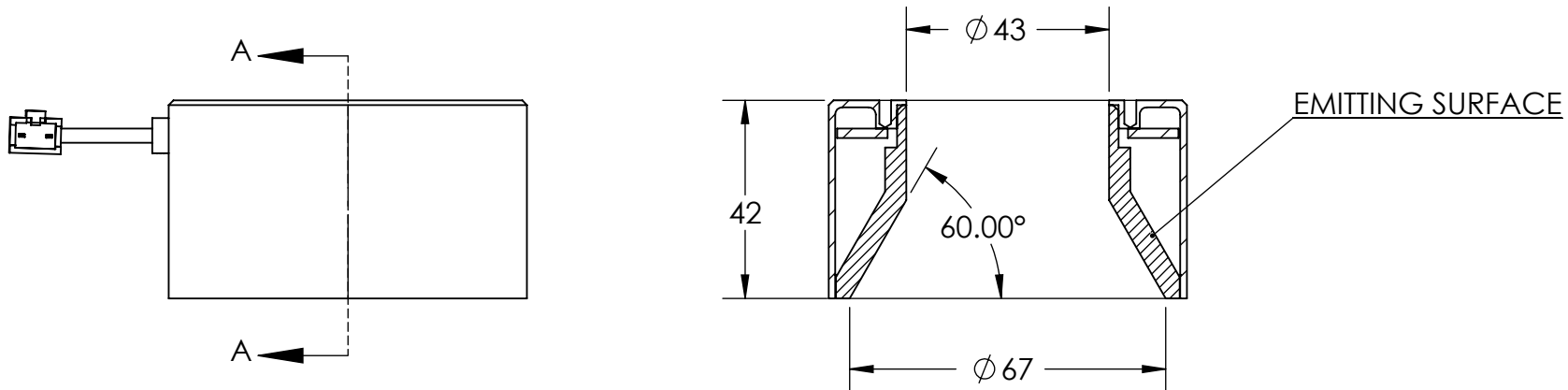

A

A

	DESIGN BY	FL LUEI	UNIT:	PRODUCT SERIES: LT2RZF SERIES	
	CHECK BY	KB TAN	MM		
	DATE	06/06/2018	REVISION:	TITLE	DRAWING LAYOUT
	MATERIAL	-	01	PART NO	LT2RZF070-60-2-B-24V
	FINISHING	-	SCALE:	DWG NO	-
QTY	-	1:1	SHEET 1 OF 1		

1 2 3 4 5 6 7 8