

Rev No.	Description	Date	Name

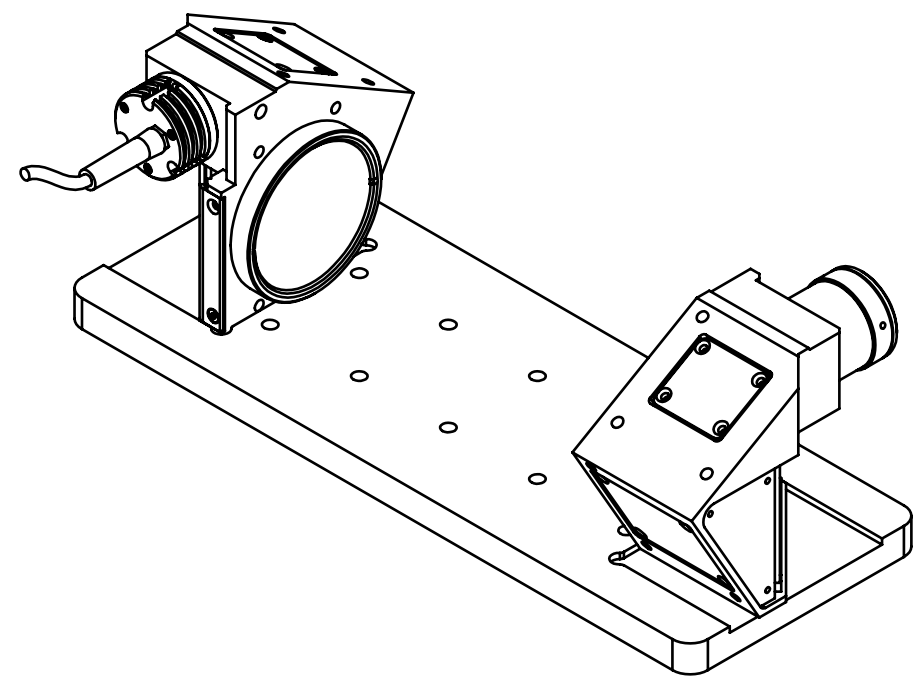

Material	N.A.		Mass	3849 g	Scale	1:3
Surface treatment	N.A.		Part No.	CO24333		
Geometrical tolerance (ISO 2768-2)	Class	K	Undimensioned bevels	0.5x45°		
Linear tolerance (ISO 2768-2)	Class	m	Undimensioned radii	R 0.5		
0.5 ±3	>3± 6	>6± 30	>30± 120	>120 ±400	>400± 1000	>1000 ±2000
±0.1	±0.1	±0.2	±0.3	±0.5	±0.8	±1.2
			Date	Name		
			Designed	16/04/2015	Vasconetto	
			Drawn	29/07/2015	Rodella	
			Checked			
			Drawing No.		Sheet	
			DP 24333-A		1/1	
<i>Secret and confidential - All rights reserved - No copy, dissemination or circulation is allowed unless specifically authorized in writing by OPTO ENGINEERING S.r.l. - Any violation shall be legally prosecuted.</i>						

all dimensions are in mm